

# WL1000GF MAX

## MANUAL



## WL1000GF MAX MANUAL

Congratulations on your choice of the **Waterlogic WL1000GF MAX Water Treatment System**. The **WL1000GF MAX Water Treatment System** model dispenses Cold, and Hot Water. Every **WL1000GF MAX Water Treatment System** includes:



**Bio-Cote<sup>®</sup> Anti-Microbial Protection**



**Advanced In-Tank Ultra7violet (UV) Purification**



**Filter configuration can be optimized for all water conditions**

The **Waterlogic WL1000GF MAX Water Treatment System** provides exceptional quality and great tasting water with every use.

## INTRODUCTION

Carefully read and follow all instructions to ensure proper and efficient operation of your **WL1000GF MAX Water Treatment System**. Contact **Waterlogic** or an **Authorized Waterlogic Dealer** if you have any questions.

**Waterlogic** and **Authorized Waterlogic Dealers** employ trained service personnel who are experienced in the installation, function and repair of **Waterlogic** equipment. This publication is written for use by these qualified individuals. **Waterlogic** encourages users to learn about products, however, we believe that product knowledge and service is best obtained by consulting **Waterlogic** or an **Authorized Waterlogic Dealer**.

**Waterlogic Water Treatment Systems** should be combined with selected water treatment components to create a system specifically tailored for each application by trained and qualified personnel.

Products manufactured and marketed by **Waterlogic** and its affiliates are protected by patents.

**Waterlogic** reserves the right to change the specifications referred to in this literature at any time, without prior notice. Changes or modifications not expressly approved by **Waterlogic** could void the warranty and user's authority to operate the equipment.

## TABLE OF CONTENTS

### USER GUIDE

- Safety Alert Symbols .....4
- Safety Precautions .....4
- Features and Benefits .....6
- Certifications .....7
- Model Designations and General Specifications .....8
- Electrical and Shipping Specifications .....9
- Operating Instructions ..... 10

### SERVICE GUIDE

- Service Requirements ..... 11
- Installation Rail..... 12
- PCB Wire Drawings..... 13
- Recommended Spares Holding ..... 14
- LED Indicator Lights..... 15
- Programming ..... 16
- Hot Tank Descaling..... 18
- Faucet Service ..... 20
- Resetting the Hot Tank Overheat (High Limit Safety) ..... 21
- Drawings and Parts List ..... 22
- Flow Diagram ..... 32
- Electrical Schematic ..... 33

### INSTALLATION GUIDE

- Pre-delivery Procedures ..... 34
- Draining Procedure ..... 37
- Installation Instructions..... 38

### TROUBLESHOOTING GUIDE

- Fault Codes Troubleshooting ..... 41
- Power Troubleshooting..... 44
- Dispense Troubleshooting..... 46
- Hot Water Troubleshooting ..... 51



## SAFETY ALERT SYMBOLS

Read and follow all safety information carefully. The signal words used in this manual are selected as shown below and based on an assessment of the degree of potential injury or damage (severe or minor) and the occurrence of injury (definitely occurs or has the potential to occur) when the warning is ignored:

 **DANGER!**

*Indicates a situation which, when not avoided, results in death or severe injury.*

 **WARNING!**

*Indicates a situation which, when not avoided, has the potential to result in death or severe injury; and/or severe property damage.*

 **CAUTION!**

*Indicates a situation which, when not avoided, results or has the potential to result in minor injury; and/or minor property damage.*

## SAFETY PRECAUTIONS

**Basic safety precautions should be followed, including the following:**

Ensure all local laws including health and safety guidelines are met when installing **Waterlogic** Equipment. Only qualified service technicians should attempt installation and service of **Waterlogic** Equipment. Always read the entire operating instructions before using the appliance and save these instructions for future use.

 **DANGER! ELECTRICAL SHOCK HAZARD.** Always use a dedicated and properly earthed outlet. Unit should be protected by residual current device (RCD) having a rated residual operating current not exceeding 30mA. Use only Waterlogic supplied power cord. Never use extension cords or power strips to connect unit. Do not use if the power supply cord is damaged. Always unplug from power supply prior to servicing.

 **WARNING! AUTHORIZED USE ONLY.** This appliance is to be used for its intended purpose as described in this manual, and untrained individuals who use this manual assume the risk of any resulting property damage or personal injury. This appliance can be used by children aged from 8 years and above and persons with reduced physical, sensory or mental capabilities or lack of experience and knowledge if they have been given supervision or instruction concerning use of the appliance in a safe way and understand the hazards involved.

 **WARNING! SUPERVISE CHILDREN.** Keep appliance and cord out of reach of children under the age of 8 years. Children under the age of 8 years must not use or play with the appliance.

 **WARNING! DO NOT OPERATE IF DAMAGED.** Unplug if abnormal case occurs. Contact Waterlogic or authorized dealer for repair, service, and installation to avoid hazards.

 **WARNING! HOT WATER.** Unit produces Hot Water in excess of 87°C (188°F). Water above 52°C (125°F) can cause severe burns or scalding. Keep unauthorized people and children away from the unit to avoid accidental dispensing of hot water.

**⚠️ WARNING! CONNECT TO POTABLE WATER SUPPLY.** *This system is to be used for water only and is not intended for use where water is microbiologically unsafe or with water of unknown quality without adequate disinfection. System is designed for the supplemental bactericidal treatment of public drinking water, or other drinking water, which has been tested and deemed acceptable for human consumption by local health agency. The system is designed to reduce normally occurring non-pathogenic or nuisance microorganisms only. System is not intended for treatment of contaminated water.*

**⚠️ WARNING! TIP HAZARD.** *Dispenser could tip or fall causing serious injury. Always install unit on a firm, flat, and level surface and secure the **WL1000GF MAX Water Treatment System** to the base cabinet with the screw provided to lock the components together. Secure unit to cabinet, wall, or floor if needed. Never place heavy items on top of unit and never climb, stand, or hang on unit or storage cabinet to prevent injury and damage.*

**⚠️ WARNING! UNIT IS HEAVY. TWO PERSON LIFT REQUIRED.** *Transport unit empty and always use material handling equipment or two people with proper lifting technique to reduce injury risk.*

**⚠️ WARNING! STORE AND TRANSPORT UNIT EMPTY. ALWAYS SANITISE BEFORE USE.** *The unit must be completely drained and sealed before storing to avoid stagnation and reduce microbiological contamination (potential bacterial growth). Sanitise before use to eliminate any potential microbiological contaminates*

**⚠️ CAUTION! INDOOR USE ONLY.** *Intended for household use only. Never expose to direct sunlight, heat sources, or ambient air temperature above 37°C (100°F) or below 2°C (35°F). Install indoors and keep unit away from excessive humidity. Never expose to freezing temperatures. Ensure there is adequate clearance around the unit to allow refrigeration system condenser to dissipate heat. Warmer environments require more clearance around the unit. Minimum clearance around all surfaces of the machine is 50mm. Installs where the ambient temperature exceeds 27°C (80°F), require a minimum of 100mm clearance for proper heat dissipation and efficient operation.*

**⚠️ CAUTION! USE A WATER PRESSURE REGULATOR.** *Waterlogic will not be responsible for injury or damage caused by excessive water pressure. Input or feed pressure must be 2.7 to 4 Bar. Be aware of any potential pressure surges caused by building/municipal pumping stations. Water block devices and external leak detectors are strongly recommended. Locate the unit as close to the water supply and the electrical connections as possible to minimize risk.*

**⚠️ CAUTION! USE PROPER SUPPLY LINES AND FEED WITH POTABLE AMBIENT WATER ONLY.** *Feed water over 37°C (100°F) may damage the treatment components. Always use supply lines with adequate pressure rating and UV resistance. Close water supply valve and contact service representative if a leak is noticed.*

**Contact Waterlogic for assistance or help finding an Authorized Service Representative.**

## WL1000GF MAX FEATURES AND BENEFITS

### Cold, and Hot Water

The **WL1000GF MAX Water Treatment System** unit comes standard with Cold and Hot Selections to meet a wide range of customer demands. Cold Water temperature is adjustable.

### High Volume Storage and Water Capacity

The **WL1000GF MAX Water Treatment System** unit has 4 litres in Cold Tank and 11.2 in the Cold-Water Reservoir (total of 15 Litres of Ice Cold Water) and 1.6 Litres of Hot Water Capacity.

### BioCote<sup>®</sup> Anti-Microbial Protection

Certain plastic, silicon, and painted surfaces surrounding the dispensing areas and drip tray are infused with an exclusive additive called BioCote<sup>®</sup>. BioCote<sup>®</sup> provides an effective barrier against microbes like bacteria and mould, which may cause odours or staining.



### Large Dispense Area with Recessed Faucet

200mm dispense height with BioCote<sup>®</sup> recessed faucet to protect from cross-contamination.

### Advanced Programming

Customizable settings for optimizing each **WL1000GF MAX Water Treatment System** including; Cold Temp Set Point, Hot Temp Set Point, Filters Timer Setting, and Energy Saver Sleep Mode

### Child Safeguard

The **WL1000GF MAX Water Treatment System** unit requires two separate buttons to be held down in the correct sequence to prevent accidental dispensing of hot water.

### In-Tank UV Purification

Industry leading In-Tank UV Purification prevents the growth of bio-film within the Stainless Steel Cold Tank.



## WL1000GF MAX CERTIFICATIONS

*Waterlogic Water Treatment Systems* have been tested, and certified to rigorous NSF and UL Standards. We believe that performance testing and certifications validate *Waterlogic* as a world-leader in water treatment systems.

### WL1000GF MAX Certifications Include



#### UL399 – Certified Drinking Water Cooler

Intertek Labs (ETL) Certified the *WL1000GF MAX Water Treatment System* to ANSI/UL 399 Standard for Drinking Water Coolers.



BPA Free - *Waterlogic* tests for BPA and declares that all of its products are Bisphenol-A FREE and contain no harmful BPA plastics.



#### NSF/ANSI-61 – Certified Drinking Water System Components NSF / ANSI 372 – Drinking Water System Components – Lead Content CSA B483.1 - Drinking Water Treatment Systems

This System has been tested and certified in accordance with NSF/ANSI-61 – Certified Drinking Water System Components, NSF / ANSI 372 – Drinking Water System Components for low Lead Content, and CSA B483.1 - Drinking Water Treatment Systems by the Water Quality Association (WQA)

*Waterlogic* is certified to ISO 9001:2015 – Quality Management Systems (certified by Intertek). ISO 9001 is the internationally accepted standard for well managed organizations that have adopted the key quality management principles to its operations to bring consistent quality products and a culture of continuous improvement.



## MODEL/PART DESIGNATIONS

| BRAND NAME          | DESCRIPTION                                   | MODEL PART NUMBER |
|---------------------|---|-------------------|
| <i>WL1000GF MAX</i> | <i>Waterlogic WL1000GF MAX</i> – Cold and Hot | GF Max            |
|                     | F-1010-FS-HC-UT6-CS-WLA                       |                   |
|                     | Serial Number Prefix - 19                     |                   |

## SPECIFICATIONS

| <u>ITEM</u>                             |   |
|---|---|
| Water Connection                        | ¼" Quick Connect  |
| Cold Water Temperature                  | Cold Water Temperature – Factory Set Point 5°C (41°F)<br>(Programmable) 3° - 7°C (37° - 45° F.)   |
| Cold Tank and Cold Water Reservoir Size | 4 Liter Cold Tank and 11.2 Cold Tank Reservoir (Total of 15L Ice Cold water capacity)             |
| Hot Water Temperature                   | Hot Water Temperature – Factory Set Point 85°C (185°F)<br>(Adjustable) 80°C – 93°C (176° - 199°F) |
| Hot Tank Size                           | 1.5 Litres  |
| Hot Water Manual Reset Overheat         | 105°C (221°F)   |
| Recommended Service Pressure            | 2.7-4Bar – Use Pressure Regulator   |
| Maximum Service Pressure                | 6.5Bar – Use Pressure Regulator   |
| Rated Service Flow Out                  | 1.89 Litres per Minute (0.5 gallons per minute)   |
| Environmental Temperature               | 2° - 37°C (35° - 100°F)   |
| UV Lamp                                 | 8 Watts   |
| Heater                                  | 500 W   |
| Pump                                    | 24V DC – 120 psi – Flow 1000ml/min  |
| Refrigerant Gas                         | R600a   |



## SHIPPING SPECIFICATIONS

| <b>ITEM</b>              | <b>WL1000GF MAX</b>                             |
|--------------------------|---|
| Width/Depth/Height       | 380 x 370 x 1140 cm (150" x 146" x 449" inches) |
| Weight (dry)             | 28Kg (62 pounds)                                |
| Width/Depth/Height – Box | 459 x 419 x 1231 cm (181" x 165" x 485" inches) |
| Weight (dry)             | 32 kg (70.5 pounds)                             |

## ELECTRICAL SPECIFICATIONS

| <b>ELECTRICAL SUPPLY</b>      | <b>220-240V/50Hz</b>       | <b>13 Amp Service</b>         | <b>Resistance <math>\Omega</math></b> |
|-------------------------------|----------------------------|-------------------------------|---------------------------------------|
| <b>COMPONENT</b>              | <b>POWER (approximate)</b> | <b>AMP DRAW (approximate)</b> |                                       |
| Heater                        | 500 Watts                  | 2.3 Amps                      | 96.8-115 $\Omega$                     |
| Compressor                    | 197 Watts                  | 0.9 Amps                      | 245-292 $\Omega$                      |
| UV Lamp System                | 8 Watts                    | 0.07 Amps                     | 6K-7.2K $\Omega$                      |
| Pump                          | 0.5 Watts                  | .004 Amps                     | 96.8K-115K $\Omega$                   |
| <b>WL1000GF MAX<br/>TOTAL</b> | <b>705.5 Watts</b>         | <b>3.27 Amps</b>              |                                       |

## OPERATING INSTRUCTIONS



The above picture shows the Front Water Dispense Buttons for the **Waterlogic WL1000GF MAX Water Treatment System**.

Place appropriate receptacle under the Hot or Cold areas for dispensing water.

For Hot Water:

1. Press and hold down the Red Hot Safety Button (LEFT hand side)
2. Press the Red Hot Dispense Button (RIGHT hand side)

**\*Both buttons must be held at the same time to dispense Hot Water. This is a safeguard when dispensing hot water to prevent accidental dispensing of hot water.**

For Cold Water: Press Blue Cold Water Select Button

## SERVICE REQUIREMENTS

**⚠ WARNING!** *Read and understand the contents of this manual before attempting to service WL1000GF MAX Water Treatment System. Failure to follow the instructions in this manual could result in death, serious personal injury, or severe property damage. Only trained and qualified technicians should attempt to install, maintain, or service Waterlogic Equipment.*

1. Visually inspect all electrical and water connections for signs of wear or damage.

**⚠ DANGER!** **HIGH VOLTAGE ELECTRICAL HAZARD.** *Unplug before inspection and service.*

2. **Waterlogic** recommends changing the UV Lamp Assembly and Wiring Harness must be replaced every 12 months.

8w UV Lamp Assembly  
Part Number CT-2083



**NOTE:** The Glow Starter shown may appear blackened which is normal.



**⚠ WARNING!** **ULTRAVIOLET RADIATION.** *Protect your skin and eyes against ultraviolet rays. Never look directly at an operating UV light. Disconnect before removing UV Lamp.*

**⚠ CAUTION!** **UV LAMPS ARE HAZARDOUS.** *Lamps are considered Hazardous Waste and must be disposed of accordingly.*

3. Clean the Quartz Sleeve that surrounds the UV lamp with a non-abrasive cloth, descaling solution, or ultrasonic bath if needed when changing UV Lamps.

**⚠ CAUTION!** **UV SYSTEM IS FRAGILE.** *Never handle the UV lamp or Quartz Sleeve with bare hands. UV Lamp and quartz sleeve must be free of oils and contaminants to ensure proper operation. Use a soft non-abrasive cloth to clean.*

4. Inspect the Quartz Sleeve O-ring for wear or damage and replace as necessary.
5. Ensure there is adequate (minimum of 50mm) clearance around the unit and clean the condenser grill and compressor fan to provide efficient cooling system operation.
6. Sanitise the Cold Tank as per instructions in the pre-installation procedures.
7. Clean and sanitise and descale external surfaces of the unit. Use only chemicals that are compatible with ABS plastic and will not damage or degrade the product surfaces.
8. Remove descale, sanitise and clean the Faucet. Replace as needed.

**⚠ WARNING!** **SANITISER MAY CONTAIN HAZARDOUS CHEMICALS.** *Use of proper personal protective equipment such as rubber gloves and eye protection is required.*

## INSTALLATION KIT

**⚠ WARNING! ALWAYS USE INSTALL KIT.** It is required to use an installation kit for the installation of any **Waterlogic Water Treatment System**. Failure to use an installation kit can result in damage due to excessive pressures over a prolonged period of time. Please check local water bylaws, in some countries an installation kit is a legal requirement.

Australian Installation in accordance with AS/NZS 3500.1 and AS/NZS 3500.2.

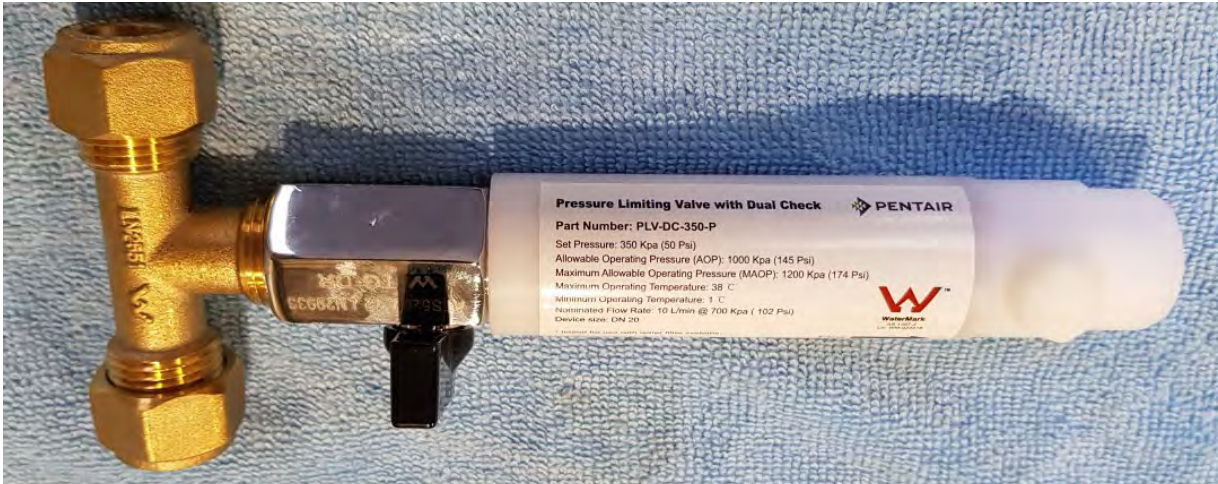

1. **K001 Install kit** as above, (1 x 63058 – brass tee, 1 x 54011 ball valve, 1 x 52028 Kemflow dual check valve)

2. **Serialised Unit**

3. **Diamond flow filter and Head** (1 x 42209 – filter 1 x 42205 head)

Options / to above

RMC PVDC50 dual check valve – 350 kpa PLV code 52010

RMC PVDC504 dual check valve – 500 kpa PLV code 52012

Accessories

1. JG ¼ sf x 3/8 stem elbow x 2 (for filter head) 60157

2. JG ¼ sf x ¼ npt tap adaptor 60175

3. Waterblock 50000

4. JG ¼ sf x ¼ sf isolating valve

5. JG ¼ tube (black only) x 5 meters (60800 / roll)

6. JG ¼ locking clips x 5 60124

# MAIN PCB WIRE DRAWING

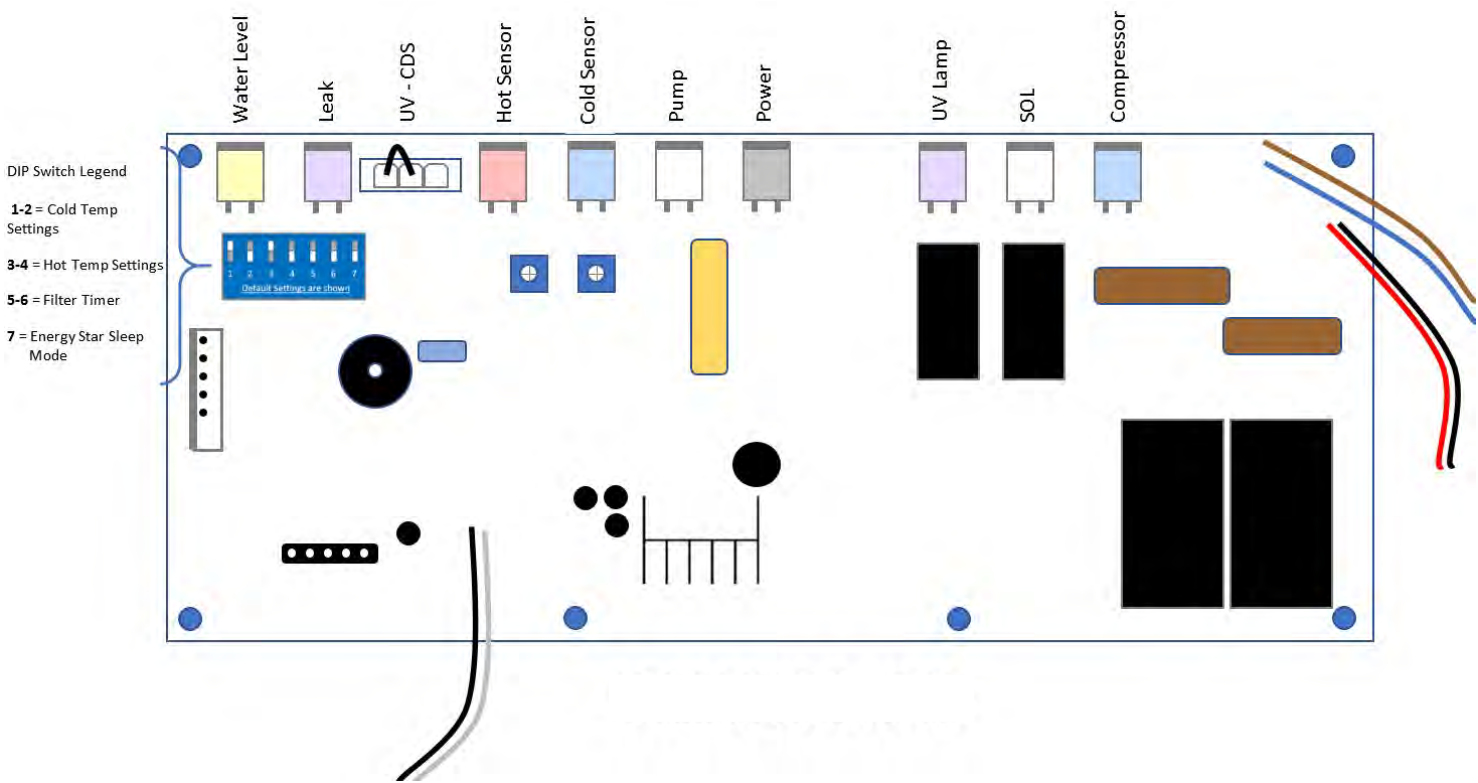

## RECOMMENDED SPARES HOLDING

| Component   | Part No.       | Stock Per 10 Machines |
|---|----------------|-----------------------|
| UV Lamp Assembly, 8 Watt  | CT-2083        | 10                    |
| Carbon Air Filter   | PU-4108        | 10                    |
| Recirculation GAC Filter  | AK-0005-L00-00 | 10                    |
| Hot Tank Assembly 1.6 Litre with Sensor 500W  | HT-0010-I00-00 | 4                     |
| GAC Filter - 10" Carbon Activated Inline Filter - <i>Optional</i>                       | FW-0035        | 20                    |
| Carbon Block - 10" CBC 1 Micron Lead and Cyst Reduction Inline Filter – <i>Optional</i> | FW-0063        | 20                    |
| Sediment Block - 10" Sediment 20 Micron Inline Filter - <i>Optional</i>                 | FW-0053        | 20                    |
| Overheat with Manual reset - 221°F (105°C)  | HT-3012        | 1                     |
| Overheats Metal Cover   | ST-8289        | 1                     |
| Quartz Sleeve for 8W Lamp   | CT-2002        | 1                     |
| Black O-Ring for Quartz sleeve  | CT-2006        | 1                     |
| Cold Water Faucet Assembly  | PL-1260-E      | 5                     |
| Hot Water Faucet Assembly   | PL-1260-D      | 5                     |
| Display PCB   | EN-0046-L00-00 | 1                     |
| Main PCB  | EN-0045-L00-00 | 1                     |
| Hot Water Safety Push Button  | PL-1265        | 1                     |
| Hot Water Push Button   | PL-1262        | 1                     |
| Middle Button   | PL-0169-L00-03 | 1                     |
| Cold Water Push Button  | PL-0148-L00-00 | 1                     |
| Drip Tray Grill   | PL-1270-C      | 2                     |
| Drip Tray Body  | PL-1289-B      | 2                     |
| Self-Suction Pump   | CT-0014-L00-00 | 1                     |
| Inlet Solenoid Valve 220V   | PU-4095        | 1                     |
| Water Level Controller with Wire  | PU-4100        | 1                     |
| UV Lamp Ballast 220V/50Hz   | EL-5044CN      | 1                     |
| Black Top Cover   | PL-1254        | 1                     |
| Silicon Seal for Inlet Port to Tanks  | PU-4109        | 1                     |

Replacement parts can be obtained from *Waterlogic* or an *Authorized Waterlogic Dealer*. See *Parts Layouts, Drawings, and Lists* for additional repair parts.

### Hot Tank Service

Hot Tanks (with controls) must be replaced at least every 5 years depending on usage. Descaling Hot Tank may be required on a regular basis depending upon filtration and local water conditions. See Service Section.

### NOTE:

At the **end of this product's life**, ensure that it is disposed of in an environmentally friendly manner which is fully compliant **with all Local Requirements and Guidelines**.

## LED INDICATOR LIGHTS

|           |            |          |
|-----------|------------|----------|
| ● Heating | ● Chilling | ● Power  |
| ● Sleep   | ● UV       | ● Filter |



- Power      Green Power LED = Power is ON; No Power LED = Power is OFF
- ★ Power      Flashing Green Power LED = Circulation Pump Fault
- Filter      Green Filter LED = Filter Timer Alarm
- Chilling      Blue Chilling LED = **WL1000GF MAX** is chilling water and the Compressor is ON.  
No Blue Chilling LED = Water is chilled to temperature and the Compressor is OFF.
- ★ Chilling      Flashing Blue Chilling LED = Cold Fault Alarm (see troubleshooting section of this manual)
- UV      Blue UV LED = UV is in operation.
- Heating      Red Heating LED = Water is heating.
- Heating      No Red Chilling LED = Water is heated to temperature.
- ★ Heating      Flashing Red Heating LED = Hot Fault Alarm (see troubleshooting section of this manual)
- Sleep      Red Sleep LED = Unit is in Sleep Mode (Energy Saver) is ON; No Red LED = Unit is not in Sleep Mode.

All but the Green Power LED Light Flashing indicates the **WL1000GF Max** has detected a leak (Please see fault finding section of this manual)

|           |            |          |
|-----------|------------|----------|
| ★ Heating | ★ Chilling | ● Power  |
| ★ Sleep   | ★ UV       | ★ Filter |

# PROGRAMMING INSTRUCTIONS

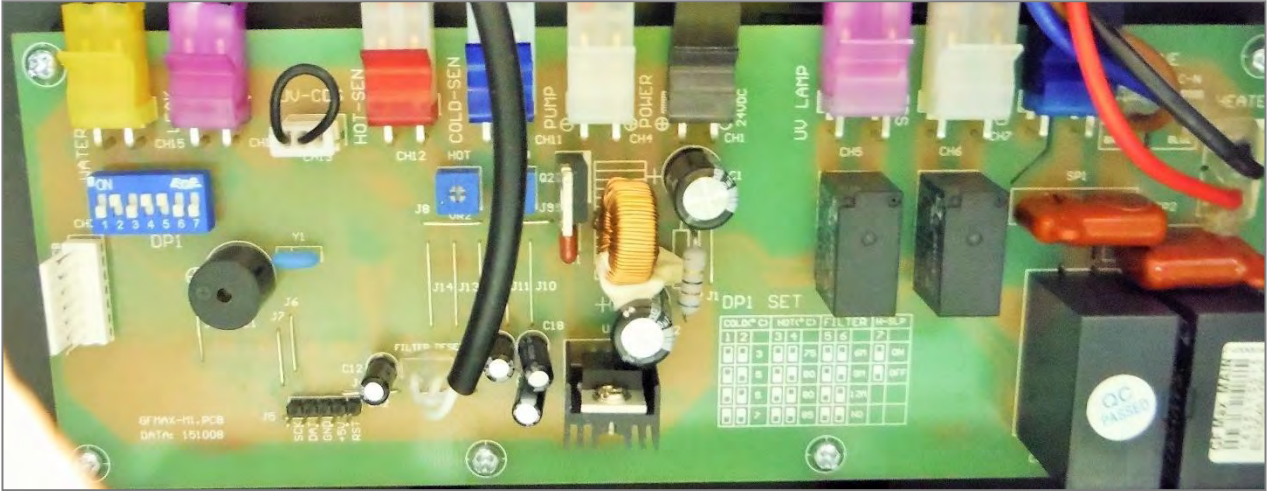

## PROGRAMMING DPI

### DIP SET-UP COLD WATER TEMPERATURE

| <b>Cold Temp</b> | <b>1</b>                 | <b>2</b>                            |
|------------------|--------------------------|-------------------------------------|
| 3°C (37°F)       | <input type="checkbox"/> | <input type="checkbox"/>            |
| 5°C (41°F)       | <input type="checkbox"/> | <input checked="" type="checkbox"/> |
| 5°C (41°F)       | <input type="checkbox"/> | <input type="checkbox"/>            |
| 7°C (45°F)       | <input type="checkbox"/> | <input type="checkbox"/>            |

Cold Temperature Factory Setting 5°C (41°F)

### DIP SET-UP HOT WATER TEMPERATURE

| <b>Hot Temp</b> | <b>3</b>                 | <b>4</b>                            |
|-----------------|--------------------------|-------------------------------------|
| 80°C (176°F)    | <input type="checkbox"/> | <input type="checkbox"/>            |
| 85°C (185°F)    | <input type="checkbox"/> | <input checked="" type="checkbox"/> |
| 85°C (185°F)    | <input type="checkbox"/> | <input type="checkbox"/>            |
| 93°C (199°F)    | <input type="checkbox"/> | <input type="checkbox"/>            |

Hot Temperature Factory Setting 85°C (185°F)



DIP SET-UP FILTER TIMER

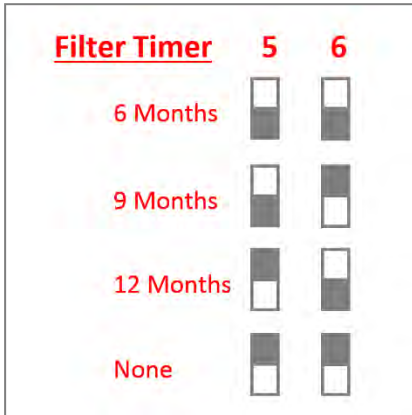

Factory Setting is None

*Filters should be configured to optimize your system. Filters need to be configured and specified to do the job given the local water conditions, usage, maintenance schedule, and placement restrictions.*

*In order for our filters to perform as represented and to provide the best quality water possible, it is essential that filters be replaced periodically. The frequency of filter changes depends on your water quality and your water usage. For example, if there is a lot of sediment and/or particles in your water, then you will have to change your filters more frequently than a location with little to no sediment. Be sure to replace your filters whenever you notice a decline in the performance, whether it is a drop-in flow rate and/or pressure or an unusual taste in the water.*



DIP SET-UP SLEEP MODE (ENERGY SAVER) When in Sleep Mode when there is no incoming water for more than three hours, the **WL1000GF MAX Water Treatment System** will go to sleep mode automatically and the Red Sleep LED light is on and the heater is turned OFF.

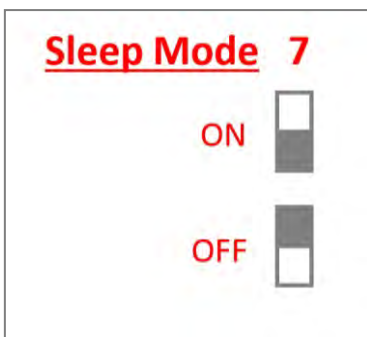

Sleep Mode Factory Setting OFF

## HOT TANK DESCALING INSTRUCTIONS

The Hot Tank requires removal of mineral deposits (descaling) on a regular basis. Typically descaling should take place every 6 to 12 months to preserve the long-term health of your unit.

Use non-toxic cleaner such as ScaleKleen, DEZCAL or 20% Citric Acid Solution to remove mineral deposits as directed by the manufacturer depending upon filtration and local water conditions.

Descaling is an important process that removes calcium deposits, or scale, that can build up inside a tank over time. Calcium and scale is non-toxic but left unattended will hinder your unit's performance.

 **WARNING!** *PERSONAL PROTECTIVE EQUIPMENT REQUIRED.* Always ensure proper ventilation and use rubber or nitrile gloves and eye protection when using chemicals. Refer to Material Safety Data Sheet for specific requirements of each product.

 **CAUTION!** *STAINLESS STEEL TANK DESCALING.* The Hot Tank is made from stainless steel. Ensure descaling solution is compatible with stainless and always flush the unit completely. Dispose in an environmentally safe manner.

### Materials Needed:

- Personal Protective Equipment. Rubber or Nitrile Safety Gloves and Protective Eyewear
- Phillips Screwdriver
- Temperature Gauge
- Water Pitcher or Container to collect water from the faucet
- 20 litre container or drain basin
- Descale solution (ScaleKleen)
- ¼" Plastic Tubing, at least 1m in length, and assorted ¼" quick connect fittings
- Sanitising Cartridge

1. Check to ensure that the Red Heater and Compressor Power Switch is the *O=OFF* position.

**NOTE:** Switches have internal LED that illuminates when placed in *I=ON* position.



2. Turn off the water supply and unplug the unit.
3. Remove Top Cover
4. Remove Reservoir Lid
5. Remove Hot Tank Drain cap on back of unit and allow all water to drain from unit.
6. When unit has finished draining, replace Hot Tank drain cap.

7. Mix descaler per instructions.
8. Add descaling mixture to Reservoir Port.
9. Turn on water supply and plug in unit.
10. Allow reservoir to fill.



11. Turn on the Red Heater and Compressor Power Switch. *I=ON* position.
12. Allow descaling mixture to remain in Hot Tank for 15 minutes (exposure time may be affected by local water conditions).
13. Flush Cold and Hot Tanks unit until all descaler is removed.
14. Ensure all outer panels and faucets are descaled during this process.



 **WARNING! HOT WATER HAZARD.** Unit Produces Very Hot Water and Steam. Always use insulated and chemically compatible containers and let unit cool down before draining the Hot Tank to avoid injury.

 **CAUTION! MUST REPLACE HOT TANK 5 YEARS DEPENDING ON USAGE.** The Hot Tank and its controls must be replaced a minimum of every 5 years depending on usage to ensure efficient and dependable operation.

 **WARNING! REINSTALL ALL PANELS AND COVERS.** Always reinstall all panels, protective covers, and fasteners after servicing equipment. Failure to do so could result in severe personal injury and will void the certifications and warranty of the equipment.

## FAUCET SERVICING

It is necessary to descale and sanitise the faucets during any service. This is to remove any minerals or contaminants that may have built up and to preserve the longevity of the WL1000GF MAX

1. Remove the gravity faucets from the WL1000GF MAX and separate the body from the head of the faucet by undoing the retaining nut.

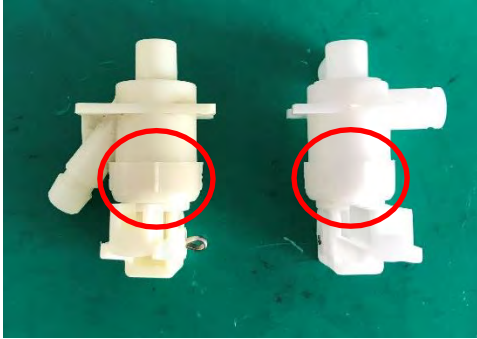





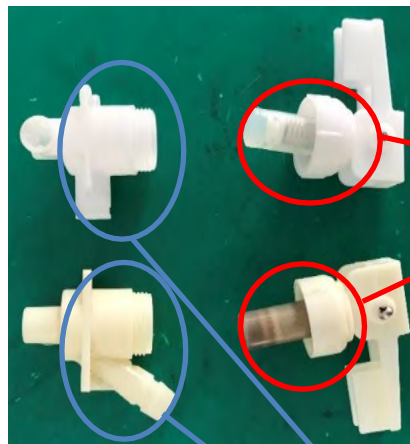

2. Once disassembled from the body, check the rubber boot has no signs of any debris or damage. There is a chance that carbon deposits from the filter can get caught up into the body and cause the rubber boot not to seat correctly onto the housing. The housing itself will also need to be checked for any signs of contaminants or damage to ensure a good seal when water is dispensed.

3. Ensure both the body and the head of the faucets are thoroughly cleaned before reassembly, if required, change the rubber boot.

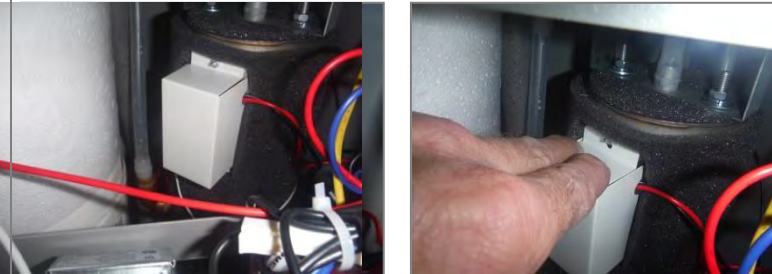

## RESETTING THE HOT TANK OVERHEAT OR HIGH LIMIT SAFETY

|    |   |   |
|----|---|---|
| 1. | Turn off Red Heater and Compressor Power Switch <i>O = OFF</i> on rear of unit.   |    |
| 2. | Unplug the Power Cord from rear of unit.  |   |
| 3. | Remove 4 Phillip Screws from the Access Panel on rear of unit and Lower Access Panel.   |    |
| 4. | Locate protective metal box on rear of Hot Tank. Push down on top of metal box to access the two Overheat Reset Devices.        |    |
| 5. | Press the Overheat Reset Devices.   |   |
| 6. | Reattach the metal box by depressing the top flap of the metal box so it snaps back into its original position on the Hot Tank. |   |
| 7. | Replace the Access Panel and 4 Philips screws.  |  |

|     |  |
|-----|--|
| 8.  | Plug in the Power Cord.  |
| 9.  | <p>Make sure the hot and cold tanks are filled with water BEFORE turning on the Red Heater and Compressor Power Switch</p> <p><b>⚠ CAUTION! NEVER TURN ON HEATER BEFORE FILLING HOT TANK.</b><br/><i>Red Heater and Compressor Power Switch must be in the O=OFF position while the Hot Tank is empty. Damage could occur within one minute and the overheat (high limit) will require manual reset if heater is turned on with an empty Hot Tank.</i></p>  |
| 10. | Verify the cooler is fully operational before installing it at the customers' site.  |

## WL1000GF MAX DRAWINGS AND PARTS LISTS

Yellow = Consumables

Green = Recommended spare parts

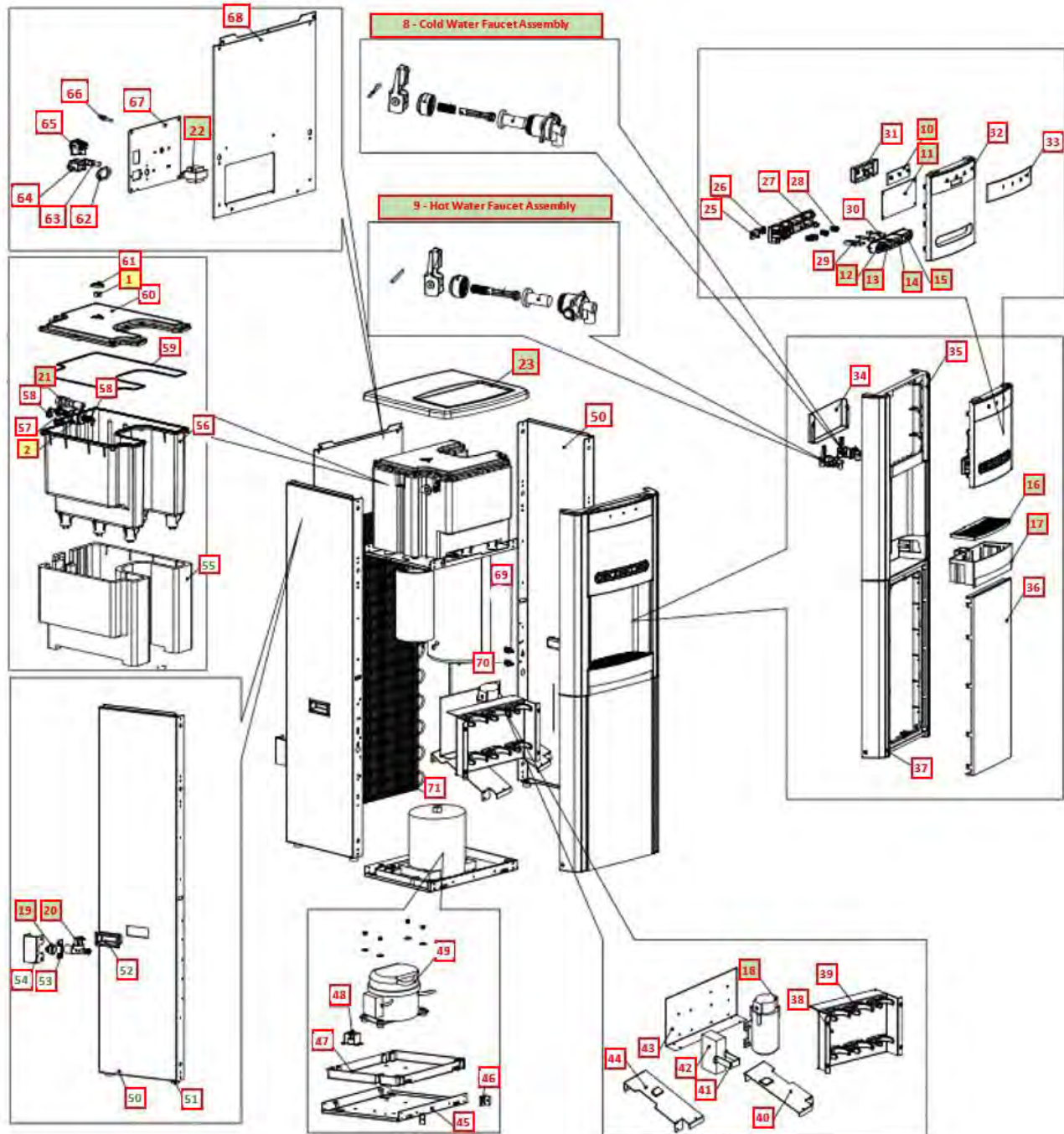

## WL1000GF MAX DRAWINGS AND PARTS LISTS





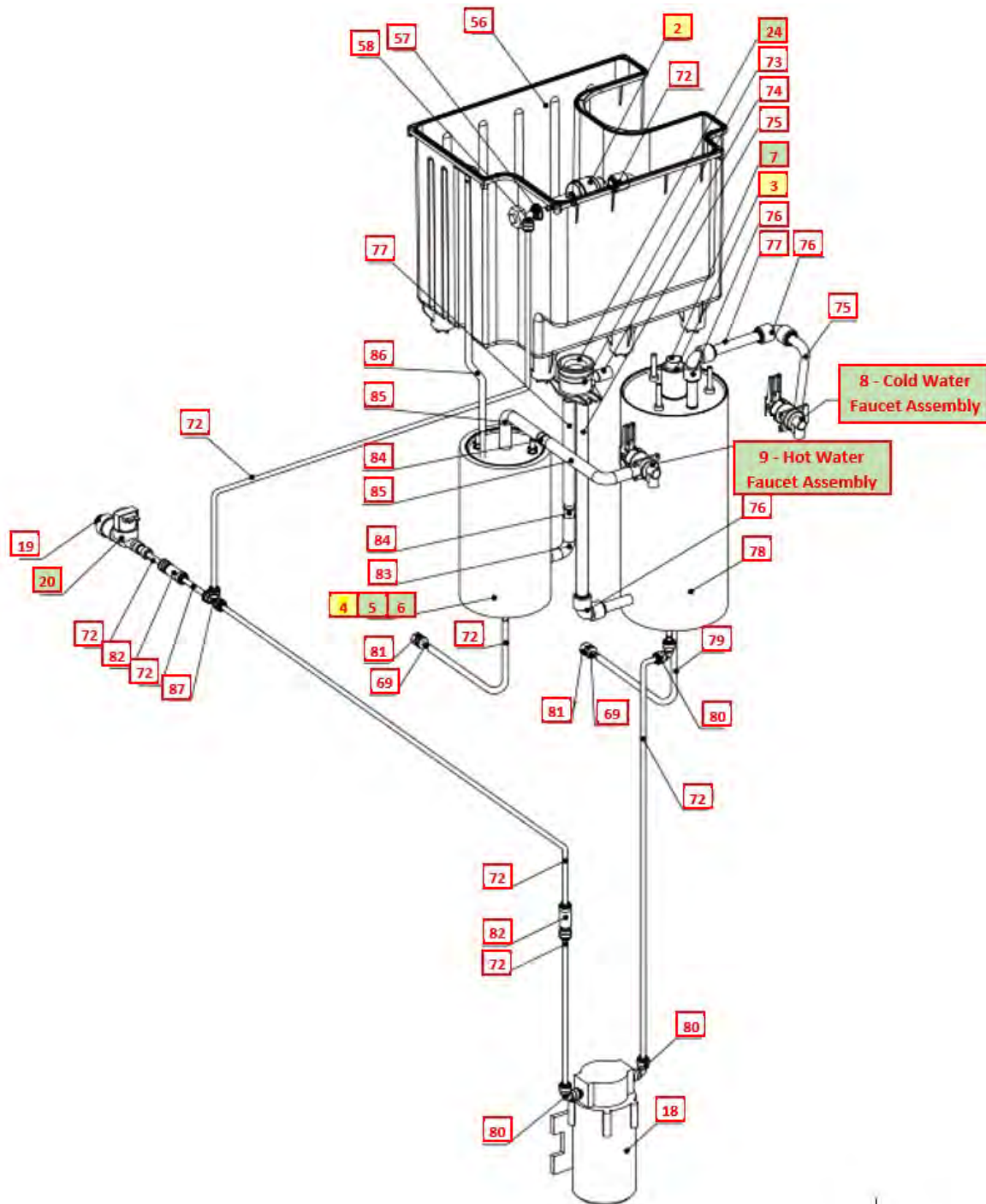

Yellow = Consumables











Green = Recommended spare parts

### Wetted Drawing















| No        | Description   | Part Number    |   |
|-----------|---|----------------|---|
| 1         | Carbon Air Filter   | PU-4108        |    |
| 2         | Small Inline GAC Filter   | AK-0005-L00-00 |    |
| 3         | 8W UV Lamp Assembly with Starter  | CT-2083        |    |
| 4         | Hot Tank with Sensor  | HT-0010-I00-00 |    |
| Not Shown | GAC Filter - 10" Carbon Activated Inline Filter – <b>Optional</b>   | FW-0035-IL-WLT |   |
| Not Shown | Carbon Block - 10" CBC 1 Micron Lead and Cyst Reduction Inline Filter – <b>Optional</b>                     | FW-0063-IL-WLT |  |
| Not Shown | Sediment Block - 10" Sediment 20 Micron Inline Filter – <b>Optional</b>                                     | FW-0053-IL-WLT |  |
| 5         | Overheat with Manual reset - 221°F (105°C)<br><i>Recommend stocking 1 each per every 10 units purchased</i> | HT-3012        |  |
| 6         | Overheats Metal Cover<br><i>Recommend stocking 1 each per every 10 units purchased</i>                      | ST-8289        |  |
| 7.1       | Quartz Sleeve for 8W Lamp<br><i>Recommend stocking 1 each per every 10 units purchased</i>                  | CT-2002        |  |
| 7.2       | Black O-Ring for Quartz sleeve<br><i>Recommend stocking 1 each per every 10 units purchased</i>             | CT-2006        |  |

|    |   |                |   |
|----|---|----------------|---|
| 8  | Cold Water Faucet Assembly<br><i>Recommend stocking 5 each per every 10 units purchased</i>   | PL-1260-E      |    |
| 9  | Hot Water Faucet Assembly<br><i>Recommend stocking 5 each per every 10 units purchased</i>    | PL-1260-D      |    |
| 10 | Display PCB<br><i>Recommend stocking 1 each per every 10 units purchased</i>                  | EN-0046-L00-00 |    |
| 11 | Main PCB<br><i>Recommend stocking 1 each per every 10 units purchased</i>                     | EN-0045-L00-00 |    |
| 12 | Hot Water Safety Push Button<br><i>Recommend stocking 1 each per every 10 units purchased</i> | PL-1265        |    |
| 13 | Hot Water Push Button<br><i>Recommend stocking 1 each per every 10 units purchased</i>        | PL-1262        |   |
| 14 | Middle Button<br><i>Recommend stocking 1 each per every 10 units purchased</i>                | PL-0169-L00-03 |  |
| 15 | Cold Water Push Button<br><i>Recommend stocking 1 each per every 10 units purchased</i>       | PL-0148-L00-00 |  |
| 16 | Drip Tray Grill<br><i>Recommend stocking 2 each per every 10 units purchased</i>              | PL-1270-C      |  |
| 17 | Drip Tray Body<br><i>Recommend stocking 2 each per every 10 units purchased</i>               | PL-1289-B      |  |
| 18 | Self-Suction Pump<br><i>Recommend stocking 1 each per every 10 units purchased</i>            | CT-0014-L00-00 |  |

|    |   |            |   |
|----|---|------------|---|
| 19 | Inlet Solenoid Valve JG Adaptor<br>1/4 (CI320816S)<br><i>Recommend stocking 1 each per every 10 units purchased</i> | PU-4104-DP |    |
| 20 | Inlet Solenoid Valve 220V<br><i>Recommend stocking 1 each per every 10 units purchased</i>                          | PU-4095    |    |
| 21 | Water Level Controller with Wire<br><i>Recommend stocking 1 each per every 10 units purchased</i>                   | PU-4100    |    |
| 22 | UV Lamp Ballast 220V/50Hz<br><i>Recommend stocking 1 each per every 10 units purchased</i>                          | EL-5044CN  |    |
| 23 | Black Top Cover<br><i>Recommend stocking 1 each per every 10 units purchased</i>                                    | PL-1254    |    |
| 24 | Silicon Seal for Inlet Port to Tanks<br><i>Recommend stocking 1 each per every 10 units purchased</i>               | PU-4109    |   |
| 25 | Hot Safety Push Button Safety Lock  | PL-1267    |  |
| 26 | Hot Water Safety Lock Spring  | CST-8327   |  |
| 27 | Faucet Bracket  | PL-1269    |  |
| 28 | Faucet Push Pin Spring  | CST-8326   |  |
| 29 | Hot Water Safety Button Pin   | PL-1266    |  |
| 30 | Faucet Push Pin   | PL-1268    |  |

|      |  |                |   |
|------|--|----------------|---|
| 31   | Display PCB Cover  | PL-1347        |    |
| 32   | Front Hatch Panel  | PL-0147-L00-00 |    |
| 33   | LED Label  | LP-0335-L00-00 |    |
| 34   | Main Printed Circuit Board (PCB) Cover   | ST-0143-L00-00 |    |
| 35   | Top Front Panel for Drip Tray<br><i>*Request to be shipped with Hot Water Safety Sticker P/JN LP-7169 WLCP PN 12-1001.</i> | PL-1255        |    |
| 35.1 | Hot Water Safety Sticker   | LP-7169        |   |
| 36   | Lower Front Insert Panel   | PL-1149-A      |  |
| 37   | Bottom Panel   | PL-1256        |  |
| 38   | Filter Bracket   | ST-0145-L00-00 |  |
| 39.1 | 3" Filter Clip   | PU-4024        |  |
| 39.2 | 2" Filter Clip   | PU-4025        |  |

|    |                                   |                |   |
|----|-----------------------------------|----------------|---|
| 40 | Rail Bracket – Right              | ST-0172-L00-00 |    |
| 41 | Adaptor Bracket                   | ST-8315        |    |
| 42 | Power Adaptor                     | EL-0126-L00-00 |    |
| 43 | Pump Bracket                      | ST-0173-L00-00 |    |
| 44 | Rail Bracket – Left               | ST-0171-L00-00 |    |
| 45 | Bottom Base                       | ST-0174-L00-00 |  |
| 46 | Side Panel Bracket                | ST-8229        |  |
| 47 | Leak Tray                         | PL-0149-L00-00 |  |
| 48 | Level Sensor Bracket              | ST-8232        |  |
| 49 | Compressor 220-240V 50hz<br>R600a | CO-0010-L00-00 |  |
| 50 | Side Panel                        | ST-8212        |  |

|    |   |                |   |
|----|---|----------------|---|
| 51 | Rubber Feet   | ST-8016        |    |
| 52 | Side Panel Plastic Handle                               | PL-1123        |    |
| 53 | Inlet Solenoid Valve Bracket                            | ST-8214        |    |
| 54 | Inlet Solenoid Valve Cover                              | ST-8233        |    |
| 55 | Reservoir Thermal Insulation                            | PL-0090-L00-BL |    |
| 56 | 3 Gallon Plastic Reservoir                              | PL-1258        |   |
| 57 | Bulkhead Union 1/4" x 1/4" John Guest P/N PI1208S       | PU-4028-A      |  |
| 58 | JG Stem Elbow Connector 1/4" * 1/4" - Acetal PI220808S) | PU-4066-A      |  |
| 59 | Reservoir Cover Silicon Seal                            | PU-4099        |  |
| 60 | Reservoir Cover   | PL-1259        |  |
| 61 | Air Filter Silicon Cap                                  | PL-1290        |  |
| 62 | Gasket for Power Socket                                 | ST-8052        |  |

|    |  |                |   |
|----|--|----------------|---|
| 63 | Fuse Holder and Fuse 220-240V / 10A with One Wire                              | EL-5052-B      |    |
| 64 | Power Line Noise Filter, ElectroMagnetic Interference filter (EMI)             | EL-5029        |    |
| 65 | Red Compressor and Heater Switch   | EL-5004        |    |
| 66 | Switch and Wire to Filter Reset Timer  | EL-0131-L00-00 |    |
| 67 | Access Metal Cover   | ST-0181-L00-00 |    |
| 68 | Back Panel   | ST-8210        |    |
| 69 | Drain Valve Body for 5/16" *14-5011 includes Drain Valve Body and Cap *See #81 | CT-2031-A      |   |
| 70 | Drain Valve Nut for 1/4" and 5/16"   | CT-2082        |  |
| 71 | Wire Condenser   | CO-0009-L00-00 |  |
| 72 | JG LLD PE Tube - Blue O.D.1/4" John Guest P/N PE-08-BI-1000F-B                 | PU-4031-A      |  |
| 73 | Water Inlet to Port to Tanks   | PL-1261        |  |
| 74 | Silicon Stopper Cap Blocks Ambient Port  | PU-4117        |  |
| 75 | 1/2" Pipe White Tubing - John Guest PN PE-16-GI-0250F-W                        | PU-4126-KR     |  |
| 76 | 1/2" Elbow fitting (PP0316W)   | PU-4141-KR     |  |

|           |  |                          |   |
|-----------|--|--------------------------|---|
| 77        | HK silicone 1/2" pipe (natural)  | PU-4126-B                |    |
| 78        | Cold Tank with Thermistor  | CT-0013-L00-00           |    |
| 79        | JG LLDPE Tube - Blue 8mm John Guest P/N PE-0806-100M-B                               | PU-4014-A                |    |
| 80        | JG Equal Elbow Connector 1/4" (PI0308S)  | Purchase from John Guest |    |
| 81        | Drain Valve Cap for 5/16" – 1/4" *14-5011 includes Drain Valve Body and Cap *See #69 | CT-202814                |    |
| 82        | JG Non-Return Valve 1/4" (1/4SCV)  | PU-4057                  |    |
| 83        | Silicon Elbow Tube Pipe 25*40  | PU-4110                  |   |
| 84        | Silicon Pipe Straight Connector  | PU-4101                  |  |
| 85        | Silicon Pipe 48.5*155 Elbow  | PU-4112                  |  |
| 86        | Silicon Pipe 5/16"   | PU-4064-L00-00           |  |
| 87        | JG Equal Tee Connector 1/4" (PI0208S)  | PU-4011-A                |  |
| Not Shown | Power Cord 220V – 1840 mm  | EL-5058CN                |  |



## WL1000GF MAX WATER FLOW DIAGRAM

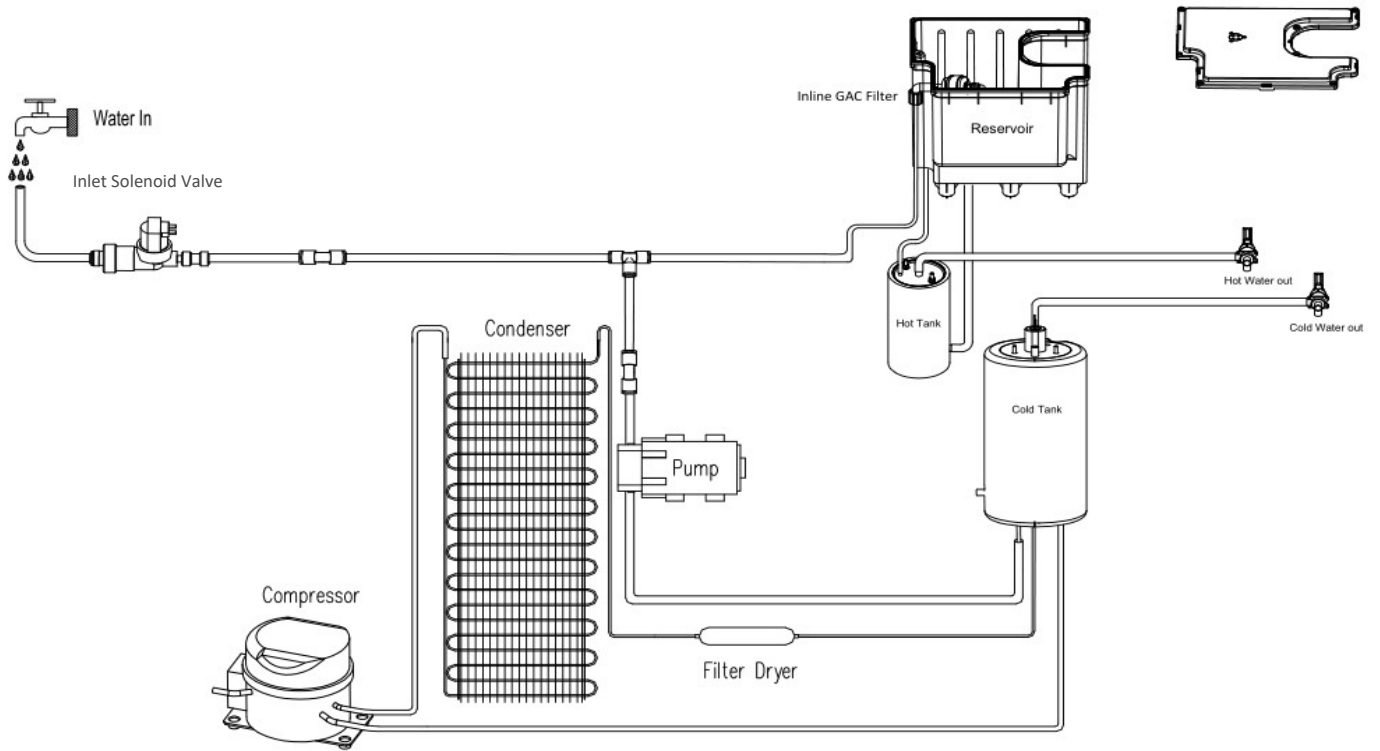

## WL1000GF MAX ELECTRICAL DIAGRAM

**⚠ DANGER!** HIGH VOLTAGE ELECTRICAL HAZARD. PCB (Printed Circuit Board) contains High Voltage. Only trained and qualified technicians should attempt live testing.

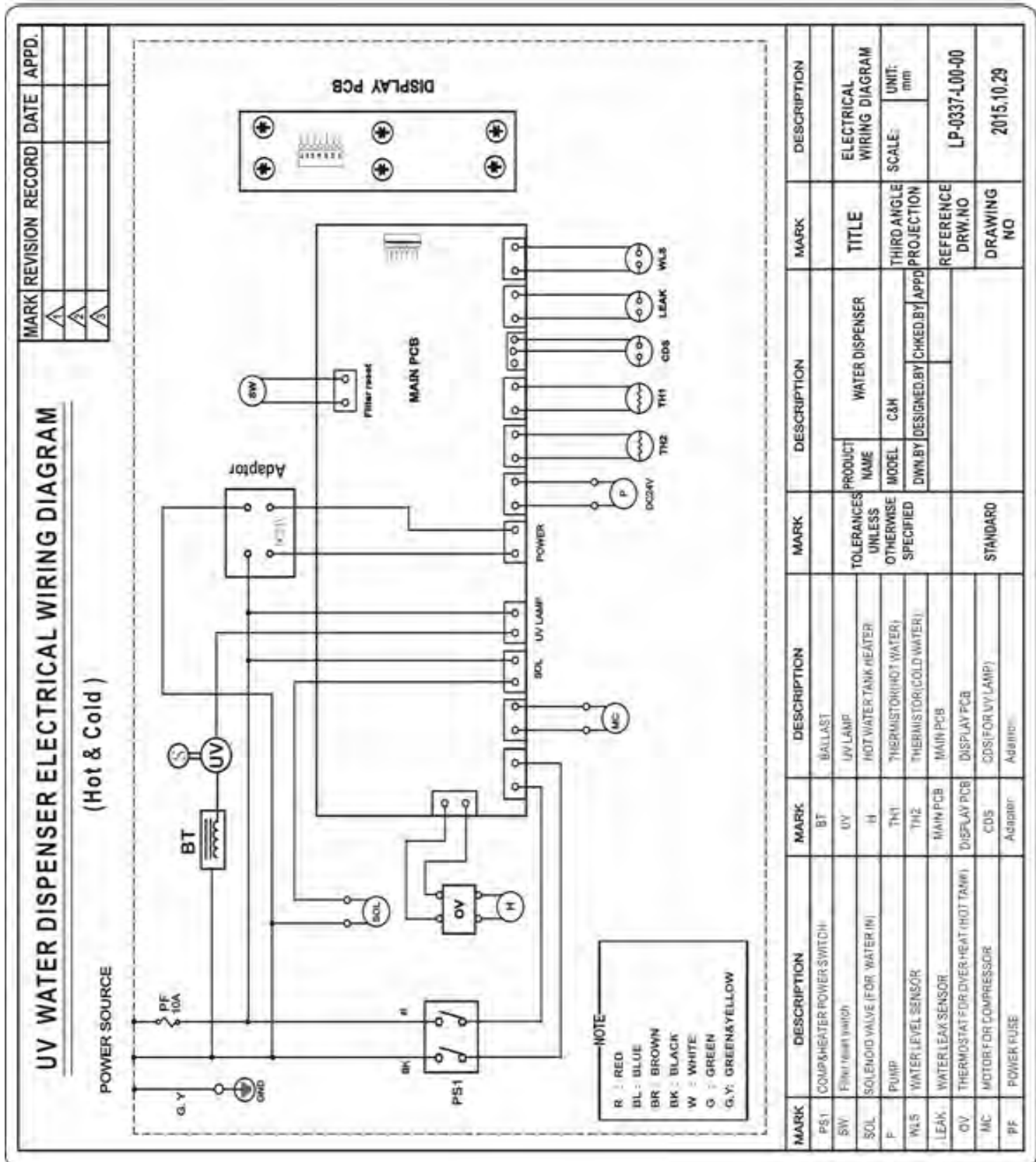

## PRE-DELIVERY PROCEDURES

**⚠ DANGER! ELECTRICAL SHOCK HAZARD.**

*Only qualified personnel who have read and understand this entire manual should attempt to install, or service this unit, failure to do so could result in death or serious injury.*

**⚠ WARNING! ALWAYS SANITISE BEFORE USE.**

*Sanitise before use to eliminate any potential microbiological contaminates.*

*Red Compressor/Heater Switch must be in the O=OFF position while the Hot Tank is empty. Damage could occur within one minute and the overheat (high limit) will require manual reset if heater is turned on with an empty Hot Tank.*



### Sanitization of Machine

#### Materials Needed:

- Personal Protective Equipment. Rubber or Nitrile Safety Gloves and Protective Eyewear
- Phillips Screwdriver
- Sanitiser – Aquadosa Or equivalent (5.25% Sodium Hypochlorite)
- Unused sponges or paper towels
- Dish Soap
- Clean water

1. Unpack the **Waterlogic WL1000GF MAX Water Treatment System** and check exterior for damage.

**⚠ CAUTION! ALWAYS SANITISE THE INTERNAL PLASTIC RESERVOIR, LID AND FLOATS PRIOR TO INSTALLATION.**

*The internal wetted surfaces of the machine have been handled multiple times in the process of manufacturing. By following the steps below, you will ensure the cleanliness and sterility of the drinking water*

2. Remove the Top Cover of the **WL1000GF MAX Water Treatment System**. The two screws securing the Top Cover are located in each rear corner.



3. Remove the Reservoir Tank Cover to access the Reservoir Tank.



- Mix 60ml of Aquadosa sanitiser as per directions or see manufactures instructions to other sanitiser products. Always ensure sanitiser is compatible with stainless steel and acetyl plastic.

**⚠ WARNING!** Use Personal Protective Equipment. Gloves and Eye Protection Required. The first 2 or 3 gallons of water will contain concentrated sanitiser. Use extreme care!

- Start filling the Reservoir Tank with clean water, after approximately ½ full add in the sanitiser. Continue to fill the Reservoir Tank with water until full.
- The Circulation Pump will turn on when adding water to the Reservoir. Allow the water with sanitiser to circulate in the Reservoir Tank for 10minutes.
- Drain the water with sanitiser by removing the Drain Valve Caps at rear of **WL1000GF MAX**. Do not reinstall the Drain Valve Nuts at this time.
- With a minimum of 10 litres of clean water, rinse out the Reservoir Tank to remove all sanitiser.



- Clean Reservoir Lid with Dish Soap and Water. Rinse thoroughly.
- Install the Hose Adaptor fitting that is packed in the accessories bag found in the drip tray onto the water inlet fitting on the back of the machine.



**⚠ CAUTION!** DO NOT OVERTIGHTEN

- Install the metal stand-off plate from the accessories bag and install over the water inlet. Connect a section of the ¼" plastic tubing from the water supply line into the hose adaptor fitting at the back of the unit.



**⚠ CAUTION!** DO NOT TURN ON THE WATER YET

**⚠ CAUTION!** FILTER FLUSHES REQUIRED.

*WL1000GF MAX Water Treatment Systems are not supplied with filters. Filters should be configured to optimize your system. Filters need to be configured and specified to do the job given the local water conditions, usage, maintenance schedule, and placement restrictions.*

*In order for our filters to perform as represented and to provide the best quality water possible, it is essential that filters be replaced periodically. The frequency of filter changes depends upon your water quality and your water usage. For example, if there is a lot of sediment and/or particles in your water, then you will have to change your filters more frequently than a location with little to no sediment. Be sure to replace your filters whenever you notice a decline in the performance, whether it is a drop in flow rate and/or pressure or an unusual taste in the water.*

12. Flush thoroughly filters with fresh water to drain.
13. Once flushed, install the filters. Following the flow direction on the filters.

**NOTE:** Filters should not be flushed prior to 24 hours before installation to limit Microbial Growth and must be flushed upon installation.

*If you intend to use the Waterlogic Reverse Osmosis System, you must remove the filter plate supplied behind the lower front panel (four screws total). The RO System then mounts on the rails just above the compressor. Route the RO drain line through the port that is protected by the rubber grommet on the back of the machine.*

*Red Compressor/Heater Switch must be in the O=OFF position while the Hot Tank is empty. Damage could occur within one minute and the overheat (high limit) will require manual reset if heater is turned on with an empty Hot Tank.*



15. Replace the Reservoir Cover and Top Cover.
16. Turn on the Red Compressor / Heater Switch. This will start the chilling and heating processes.

*Red Compressor/Heater Switch must be in the I=ON position.*



17. Verify the compressor starts by feeling the head of the compressor for vibration. The temperature in the cold tank should reach its target temperature within 45 minutes. When the unit has reached target cold temperature, the compressor will cycle off. The Hot Tank will take considerably less time to reach its target temperature of 85°C(185°F).
18. After the cold and hot water temperatures, have been reached, turn the Red Heater/Compressor Switch off.

*Red Heater and Compressor Power Switch must be in the O=OFF position while the Hot Tank is empty. Damage could occur within one minute and the overheat (high limit) will require manual reset if heater is turned on with an empty Hot Tank.*



## DRAINING INSTRUCTIONS

Drain the **WL1000GF MAX** Water *Treatment System* for transportation.

**⚠ WARNING! STORE UNIT EMPTY. ALWAYS SANITISE BEFORE REUSE.**

*The unit must be completely drained and sealed before storing to avoid stagnation and reduce microbial growth).*

Prior to draining the Hot Tank, turn off the Red Heater and Compressor Power Switch *O = OFF*, and dispense 2 litres of hot water from the machine. As hot water is dispensed from the faucet of the unit, colder water will be introduced into the Hot Tank. Since the Red Power switch is turned off, the heater will not energize and heat the incoming tap water. Following this precaution prevents exposing personnel and equipment (drains, catch basin, etc.) to scalding hot water.



### Disable Cold and Hot Tanks

1. Turn off the Red Heater and Compressor Power Switch to disable the heater and compressor.
2. Dispense 2 litres of water through the Hot Tank to cool the water temperature in the Hot Tank and avoid burns.



**⚠ WARNING! HOT WATER CAN BURN OR SCALD.**

*Hot water should be dispensed carefully into insulated container to avoid injury.*

### Turn off Water Supply and Bleed Water Pressure

3. Isolate the unit from feed water by turning off the supply.
4. Dispense cold still water to relieve any pressure built up in the system.
5. Remove the water supply line from the hose adaptor.

### Drain the Cold Water Tank and Circuit

6. Remove Hose Adaptor.
7. Remove both Drain Caps located on back of unit.
8. After unit drains, replace drain caps.

## INSTALLATION PROCEDURES

### Safety and Installation Guidelines

Ensure all Local Laws and Codes of practice, including health and safety guidelines are met when installing **Waterlogic** Equipment. Only qualified service technicians should attempt installation and service of **Waterlogic** Equipment.

 **WARNING! ELECTRICAL SHOCK HAZARD.** Always unplug (isolate from power supply) to prevent electrical shock except where electrical tests are specified.

 **WARNING! IMPROPER SUPPLY OR CONNECTION CAN RESULT IS RISK OF SHOCK.** Connect to a 13 amp 220-240V 50Hz earthed outlet (RCD recommended). Ensure polarity is correct and always use a 3-prong outlet. Consult a qualified electrician if you have any questions.

 **WARNING! USE ONLY Waterlogic SUPPLIED POWER CORD.** Locate system within 1 meter of power supply. Never use an extension cord or adapter. Do not use a damaged power cord or plug. Keep power cord out of heavy traffic areas and away from heat sources. Do not, under any circumstances, remove earthing or alter the power cord. Never pull the power plug from the outlet with a wet hand or allow the plug to get wet. Failure to use the supplied power cord will void UL Certification and Warranty.

 **CAUTION! INDOOR USE ONLY.** Never expose to direct sunlight, heat sources, or ambient air temperature above 37°C (100°F) or below 2°C (35°F). Install indoors and keep unit away from excessive humidity. Never expose to freezing temperatures. Ensure there is adequate clearance around the unit to allow refrigeration system condenser to dissipate heat. Warmer environments require more clearance around the unit. Minimum clearance around all surfaces of the machine is 50mm. Installs where the ambient temperature exceeds 26°C (80 °F), require a minimum of 100mm clearance for proper heat dissipation and efficient operation.

 **CAUTION! USE A WATER PRESSURE REGULATOR.** **Waterlogic** will not be responsible for injury or damage caused by excessive water pressure. Operating pressure must be 2.7 to 4 Bar. Be aware any of potential pressure surges caused by building/municipal pumping stations.

 **CAUTION! USE UV STABILIZED SUPPLY LINES.** Feed the unit with a potable ambient or cold water supply only. Feed water over 37°C (100°F) can damage the treatment components. Water block devices and external leak detectors are strongly recommended. Locate the unit as close to the water supply and the electrical connections as possible.

 **WARNING! STORE AND TRANSPORT UNIT EMPTY. ALWAYS SANITISE BEFORE USE.** The unit must be completely drained and sealed before storing to avoid stagnation and reduce microbiological contamination (potential bacterial growth). Sanitise before use to eliminate any potential microbiological contaminates

Pre-installation and sanitization procedures as prescribed in this manual must be performed before installing the **WL1000GF MAX Water Treatment System**.

Always install indoors and place the **Waterlogic WL1000GF MAX Water Treatment System** on a firm, flat and stable surface.

1. Attach the water supply line to the 1/4" feed water hose adaptor fitting on the back of the unit. **Waterlogic** requires the use of a water pressure regulator. Water feed pressure must be between 2.7-4Bar. Turn on the water supply and check for leaks.

2. Verify that the Red Heater and Compressor Power Switch is the O=OFF position.

**NOTE:** Switches have internal LED that illuminates when placed in I=ON position.



**⚠ CAUTION! NEVER TURN ON HEATER BEFORE FILLING HOTTANK.**

*Red Heater and Compressor Power Switch must be in the O=OFF position while the Hot Tank is empty. Damage could occur within one minute and the overheat (high limit) will require manual reset if heater is turned on with an empty Hot Tank.*

3. Connect the power cord to the back of the **Waterlogic WL1000GF MAX Water Treatment System** and to a 220-240 Volt supply.

4. Turn on water supply and allow reservoir to fill.

5. Fill the Cold Tank. Hold a container under the dispensing faucet, press and hold the cold dispensing button until a continuous flow of water is obtained. Once a continuous flow is obtained, release the dispensing button. Cold Tank is now full.



6. Fill the Hot Tank. Hold a container under the dispensing faucet. Press and hold down the Red-Hot Safety Button (LEFT hand side) dispensing button followed by the Pressing and Holding down the Hot Dispensing Button at the same time until a continuous flow of water is obtained. Once a continuous flow is obtained, release the hot water dispensing button. Hot Tank is now full.

7. Verify that the UV lamp operates as expected.

 **WARNING! ULTRAVIOLET RADIATION.** Protect your skin and eyes against ultraviolet rays. Never look directly at an operating UV light. Always disconnect before removal.

8. Move the **Waterlogic WL1000GF MAX Water Treatment System** into its final operating position. Be sure that a minimum of 50mm clearance is maintained around both the sides and the back of the unit. This is important to allow proper airflow and heat exchange of refrigeration system.

9. Level unit using the adjustable feet to level if necessary. Never install on incline.



10. Turn the Red Heater and Compressor Power Switch to *I=ON* position.

11. When the unit has reached its Hot Temp Set Point, the heater will cycle off. When the unit has reached its Cold Temp Set Point Temperature, the compressor will cycle off.

12. Once the unit is at the target temperature(s), sample the water to ensure water meets expectations and additional rinsing or adjustment is not required.

13. Check the unit for any leaks.

## FAULT CODES

### Fault Code Index

1. Cold Sensor Fault
2. Hot Sensor Fault
3. Filter Service
4. Pump Fault

*Included in this section are instructions to Reset the Hot Tank Overheat (High Limit Safety)*

### 1. Cold Sensor Fault

**Alarm: User Interface Blue Chilling LED flashing, Compressor is OFF and unit will alarm 20 times.**



The factory Cold Water temperature set point is 5°C (41°C). The Thermistor that controls the refrigeration system is located in the well in the UV Cold tank.

| Possible Reason       | Solution  |
|-----------------------|---|
| Cold Water Thermistor | Check continuity of thermistor with multimeter. Replace Thermistor as needed. |

## 2. Hot Sensor Fault

**Alarm: User Interface Red Heating LED flashing, and unit will alarm 20 times.**



The Hot temperature set point is 85°C (185° F) and is controlled by a thermistor in the well in the Hot Tank.

There are two resettable overheats or high limit safety devices on the side of the tank that will trip to prevent damage to the unit if the tank is dry heated (turned on without water in it).

It typically takes 10 minutes for the 500W to heat the 1.6 Litre of room temperature (ambient) water to the 85°C set point.

| Possible Reason      | Solution  |
|----------------------|---|
| Hot Water Thermistor | Check continuity of thermistor with multimeter. Replace Thermistor as needed. |

## 3. Filter Service Alert

**Alarm: User Interface Green Filter LED flashing, and unit will alarm 20 times.**



Factory Setting Timer for Filters Life is turned off. When the Filter Life Timer has been programmed to 6, 9 or 12 months the Filter Service Alert will alarm to recommend replacing the filters.

| Possible Reason                                | Solution  |
|--|---|
| Filter Life Time programmed has been exceeded. | Change Filter.<br><br>Reset Filter Life Timer by pressing the Red Reset button located at the back panel on rear of unit for 3 seconds. Unit will alarm 3 times to indicate that Filter Timer has been reset. |



#### 4. Pump Fault

Alarm:

- User Interface Green Power LED flashing,
- Pump is Off,
- Compressor Off,
- UV Lamp and
- Ballast are OFF



| Possible Reason           | Solution                              |
|---------------------------|---------------------------------------|
| Pump ran for over 8 hours | Power Off Machine<br>Power On Machine |

## POWER TROUBLESHOOTING INDEX

1. No Power
2. Water is not being Heated or Chilled
3. Compressor Runs but does Not Chill
4. Compressor is Not Running

### 1. No Power

| Possible Reason   | Solution   |
|-------------------|--|
| No power supplied | Verify the building electrical supply to the <b>WL1000GF MAX Water Treatment System</b> unit is on.<br><br>Verify the power cord is plugged in.<br><br>Verify the power indicator light is on.<br><br>Test the fuse.<br><br>Start normal electrical fault finding procedures using the electrical diagram located in this manual |

### 2. Water is Not being Heated or Chilled



| Possible Reason                                  | Solution   |
|--|--|
| Red Heater and Compressor Switch on unit is off. | Turn Red Heater and Compressor Switch on.<br><i>I = ON</i> |



### 3. Compressor Runs But Does Not Chill

| Possible Reason                 | Solution  |
|---------------------------------|---|
| Condenser is dirty              | Clean the condensing coil of any obstructions or dust.                        |
| Reduction of airflow into unit. | Make sure unit is not under minimum ventilation requirements (50mm to 100mm). |
| Compressor is running very hot. | Low or lost refrigerant. Refrigerant recharge required.                       |

### 4. Compressor is Not Running

| Possible Reason  | Solution  |   |
|--|---|---|
| Red Heater and Compressor Power Switch button on unit is in the off position | Turn Red Heater and Compressor Power Switch on. <i>I = ON</i>   |   |
| Compressor Starting Circuit  | <p>Turn Red Heater and Compressor Power Switch off. <i>O = OFF</i>.</p> <p>Remove the compressor cap on side of the compressor;</p> <p>Disconnect the black and red terminal connectors;</p> <p>Inspect the starter and overheat relay for any defects.</p> <p>Replace components(s) as needed.</p> <p>Turn Red Heater and Compressor Power Switch on <i>I = O and</i> retest compressor operation.</p> |  |
| Check the Cold Water Thermistor  | Check continuity of thermistor with multimeter. Replace Thermistor as needed.   |   |

## DISPENSING TROUBLESHOOTING INDEX

1. Hot Water flow, Cold Water does not flow
2. Cold Water flows, Hot Water does not flow
3. Low Flow of Water
4. Restricted Flow of Hot Water
5. No Water Will Dispense from Unit
6. Small Amount of Water Periodically Dispenses from Faucet Automatically
7. Dispense Buttons Stick

*Included in this section are the Draining Instructions.*

### **1. Hot Water flows, Cold Water does not flow.**

| Possible Reason                      | Solution  |
|--------------------------------------|---|
| Cold tank frozen                     | Disconnect power supply for one hour to allow tank to defrost.<br><br>Flush the cold-water system.<br><br>Check that the cold thermistor settings are correct Cold Water Temperature – Factory Set Point 5°C (41°F) (Adjustable 3° - 7° C (37°F - 45°F)). |
| Mechanical Water Outlet Faucet Valve | Check that the mechanical water outlet faucet valve is operating correctly and that water flows through it.   |

## 2. Cold Water Flows, Hot Water does not flow.

| Possible Reason | Solution  |
|-----------------|---|
| No Hot Water    | <p>Verify the pipes feeding the Hot Water Tank.</p> <p>Check that the mechanical water outlet faucet valve is operating and the water flows through it.</p> |

## 3. Low Flow of Water – Rated Service Flow is 1.89 Litres (0.5 gallons) per Minute

| Possible Reason             | Solution   |
|-----------------------------|--|
| Determine Flow of Water     | <p><b>Rated Flow Rate is 1.89 Litres (0.5 gallons) per minute.</b></p> <p>Check flow rate by dispensing into a container to measure for one minute and measure the amount of water that was dispensed.</p>   |
| Water pressure              | <p>Verify that the water pressure is at the recommended 2.7 to 4 Bar for <b>WL1000GF MAX Water Treatment System</b> to operate properly. Check with pressure regulator.</p>  |
| Filter or Membrane blockage | <p>Verify that the Reverse Osmosis filters or membrane are not blocked.</p>  |
| Solenoid                    | <p>Verify the inlet function solenoid functions.</p>   |
| Mechanical float valve      | <p>Verify the mechanical float valve is functioning correctly.</p>   |
| Reservoir is blocked        | <p>Check that the spout of the Reservoir is not blocked.</p>   |
| Faucet blocked              | <p>Check that the faucet valves have no blockage or restriction.</p> <p>Check that the feed pipe to the faucet valves is not kinked.</p>   |
| Tanks not full              | <p>Verify the reservoir is full and water flows into the Hot and Cold tanks. During excessively high machine usage, the Reservoir water level may be low and this can affect the water flow.</p> <p>The RO system will need more time to refill the Reservoir.</p> |



#### 4. Restricted Flow of Hot Water

| Possible Reason                                  | Solution   |
|--|--|
| Partially closed water supply valve to the unit. | Open water supply valve.   |
| Hot Tank outlet hole is scaled over.             | Remove outlet tube from Hot Tank to faucet. Add descaler to Hot Tank.  |
| Tubing is creased or has a “kink” in it.         | Inspect and replace tubing as necessary.   |
| Faucet nipple screen mesh has obstruction(s)     | Unscrew faucet nipple from faucet and remove any obstruction(s) from screen mesh.  |
| Exhausted Filter                                 | Replace the Filter   |
| Solenoid connection to the Display PCB           | Turn power off; unplug the unit and visually inspect solenoid connections into the Display PCB. Verify the soldering points on connections are secure into the board.<br><br>Remove the PCB to inspect the front of the board. |
| Solenoid Valve is Malfunctioning                 | Inspect valve components for proper function. Replace as necessary.  |

#### 5. No Water Will Dispense from Unit

| Possible Reason   | Solution  |   |
|---|---|---|
| Closed water supply valve   | Open the water supply valve.  |   |
| The unit is not properly plugged into electrical outlet                       | Check electrical outlet connection, or for blown circuit breaker.                                 |   |
| Red Heater and Compressor button on unit is in the off position               | Turn Red Heater and Compressor switch on.<br><i>I = ON</i>  |  |
| Fuse Blown  | Replace the Fuse as needed.   |   |
| Water is present in the bottom tray, causing the leak detection to trigger. . | Remove the top cover and front panel. Tip the unit slightly to drain, dry bottom tray completely. |   |
| Exhausted Filter / Membrane   | Replace filters / membrane as needed.   |   |

## 6. Small Amount of Water Periodically Dispenses from Faucet Automatically

| Possible Reason  | Solution   |
|--|--|
| Obstruction in solenoid housing is preventing proper sealing of component. | <p><u>Drain unit according to Drain Instructions that are included further below in this Troubleshooting Section.</u></p> <p>Remove Reservoir Tank</p> <p>Open Faucet Housing and check for Debris.</p> <p>Put faucet back together, replace reservoir and fill unit. If faucet continues to drip, replace the faucet.</p> |

## 7. Dispense Buttons Stick

| Possible Reason  | Solution   |
|--|--|
| Dirt or Foreign material is filling the gap around the push-buttons. | <p>Inspect the push buttons and clean surrounding area.</p> <p>Inspect faucet assembly inside the unit and clean as necessary.</p> |

## 8. Water Leaks

| Possible Reason | Solution   |
|-----------------|--|
| Water Leak      | <p>Most leaks will be detected by the internal <b>WL1000GF MAX Water Treatment System</b> leak detection system that will trigger or turn off the inlet solenoid valve.</p> <p>Isolate the supply and start normal fault finding procedures.</p> |

## DRAINING INSTRUCTIONS

Drain the **WL1000GF MAX** Water *Treatment System* for transportation.

 **WARNING!** *STORE UNIT EMPTY. ALWAYS SANITISE BEFORE REUSE.*

*The unit must be completely drained and sealed before storing to avoid stagnation and reduce microbial growth).*

Prior to draining the Hot Tank, turn off the Red Heater and Compressor Power Switch *O = OFF*, and dispense 2 litres of hot water from the machine. As hot water is dispensed from the faucet of the unit, colder water will be introduced into the Hot Tank. Since the Red Power switch is turned off, the heater will not energize and heat the incoming tap water. Following this precaution prevents exposing personnel and equipment (drains, catch basin, etc.) to scalding hot water.



### Disable Cold and Hot Tanks

1. Turn off the Red Heater and Compressor Power Switch to disable the heater and compressor.
2. Dispense 2 litres of water through the Hot Tank to cool the water temperature in the Hot Tank and avoid burns.



 **WARNING!** *HOT WATER CAN BURN OR SCALD.*

*Hot water should be dispensed carefully into insulated container to avoid injury.*

### Turn off Water Supply and Bleed Water Pressure

3. Isolate the unit from feed water by turning off the supply.
4. Dispense cold still water to relieve any pressure built up in the system.
5. Remove the water supply line from the hose adaptor.

### Drain the Cold Water Tank and Circuit

6. Remove Hose Adaptor.
7. Remove both Drain Caps located on back of unit.
8. After unit drains, replace drain caps.

## HOT WATER TROUBLESHOOTING INDEX

### 1. Hot Water is not Hot (85° +/- 3° C)

The Hot temperature set point is 85°C and is controlled by a thermistor in the well of the Hot Tank.

There are two resettable Overheat Devices or high limit safety side of the Hot Tank that will trip to prevent damage to the unit if the tank is dry heated (turned on without water in it).

It typically takes 10 minutes for the 500W to heat the 1.6 Litre of room temperature (ambient) water to the 85°C set point.

| Possible Reason  | Solution  |
|--|---|
| No power to heater elements  | Check that the Red Heater and Compressor switch is on.<br><br>Turn Red Heater and Compressor Switch on.<br><i>I = ON</i>                                     |
| Hot Tank Overheat Tripped<br><br><i>Overheat is a safety feature to ensure the tank does not overheat.</i> | Overheat will “click” when pushed. The overheat is automatically reset when pressed.<br><br><u><b>See Resetting the Hot Tank Overheat or High Limit Safety Instructions that are included further below in this Troubleshooting Section</b></u> |
| Overheat Devices “open” on Hot Tank  | Turn Power off. Check OHM’s resistance across terminals on each Overheat separately.<br><br>Good components will indicate a closed circuit or zero OHM’s on the meter.<br><br>Replace components as necessary.                                  |
| Loose or improperly connected wire(s) to the heating element / hot tank.                                   | Visually inspect wire leads going to the hot tank; confirm proper connections to the heating elements.<br><br>Hot tank life is 5 years, depending on usage.   |
| Heating Coil not Working   | Turn Power off; Drain hot tank; Use multi-meter to check heater element for approximately 26 OHM’s resistance.<br><br>Hot tank must be empty if you are checking for continuity.<br><br>Replace Hot Tank as necessary.                          |